

# Multilingual Version

## [Overview](#)

### [Quick Setup \(Wired Model\)](#)

### [Quick Setup \(Wireless Model\)](#)

# PUSH VIDEO

## PRODUCT OVERVIEW

### Package Content

Before starting to set up your camera, please make sure items below in your box:

▼ Standard package:

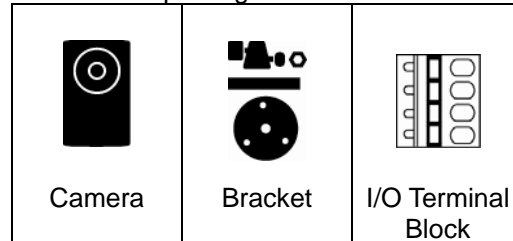

▼ Selected models only:

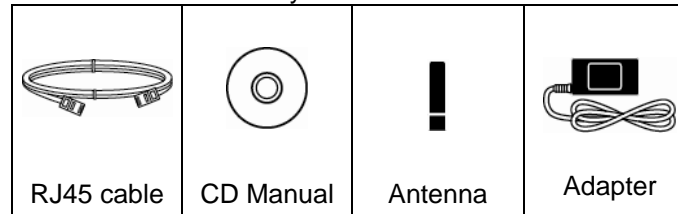

### Insert Micro SD Card

**Only selected models are equipped with a micro SD card slot for local video recording.**

The data originally saved in the micro SD card (if any) will be removed after inserting it to the camera.

The camera doesn't support hot-swapping. Please insert or remove the micro SD card with power disconnected.

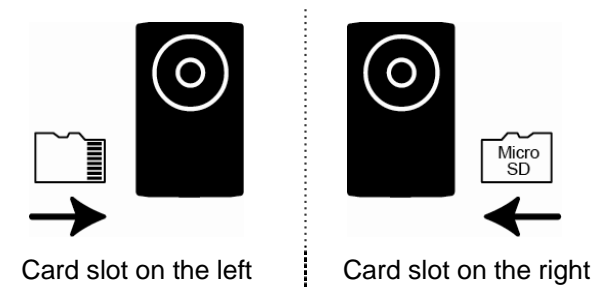

### I/O Terminal Block

This camera supports external I/O device connection, and a 4-pin I/O terminal block is supplied with this camera for easy connection.

Below shows which input on the I/O terminal block you should use for wiring when you want to connect an external device to this camera.

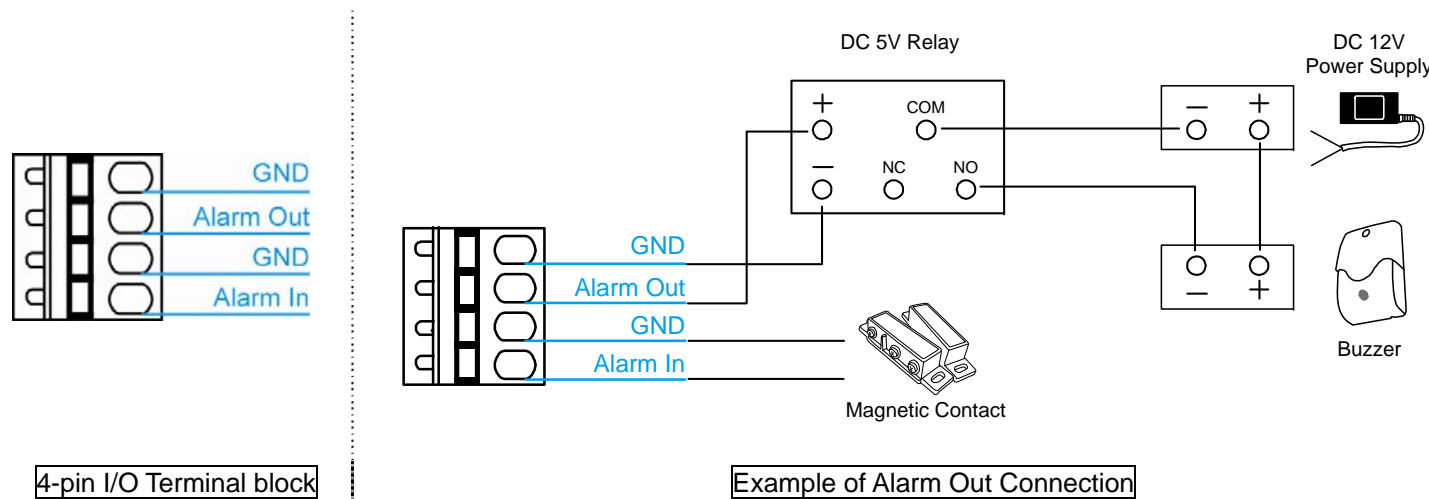

### Assemble & Install

1. Fasten the base of the bracket (the round one) to where the camera is installed.

The distance between your camera and the location you want to monitor should be 3 ~ 4 meters.

2. Assemble the bracket and the camera, and adjust the viewing angle of the camera.

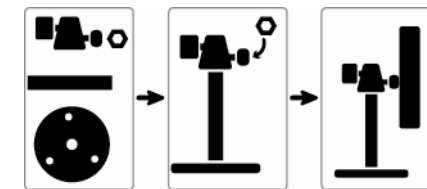

3. (For wireless models only)  
Fasten the antenna for wireless network connection.

4. Connect your camera to power, and check the LED status indicators to make sure the camera is powered on.

## Hardware Overview

### Type 1:

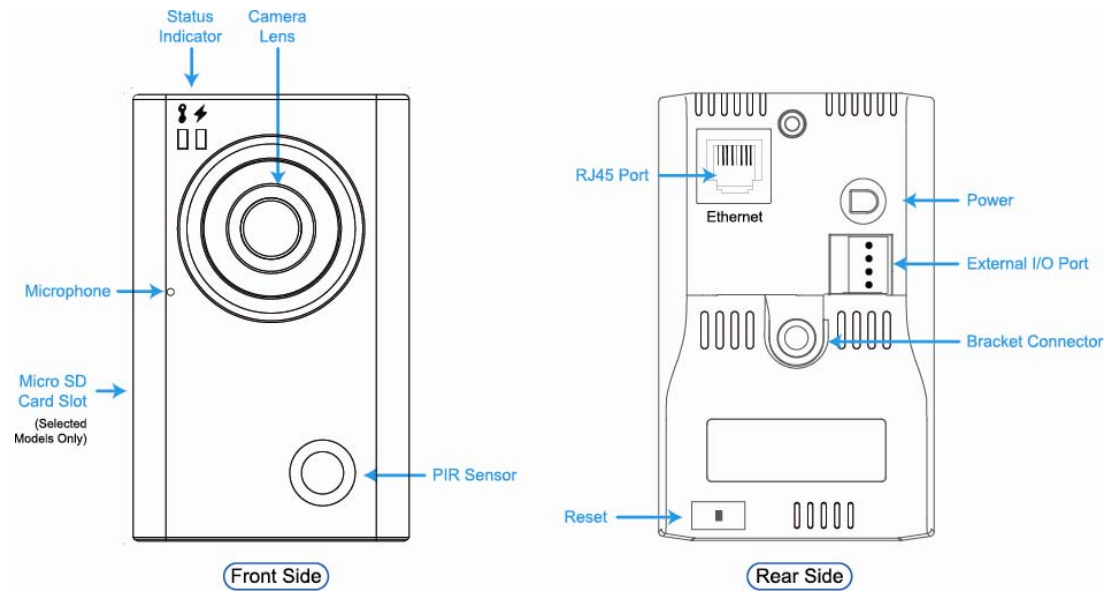

### Type 2:

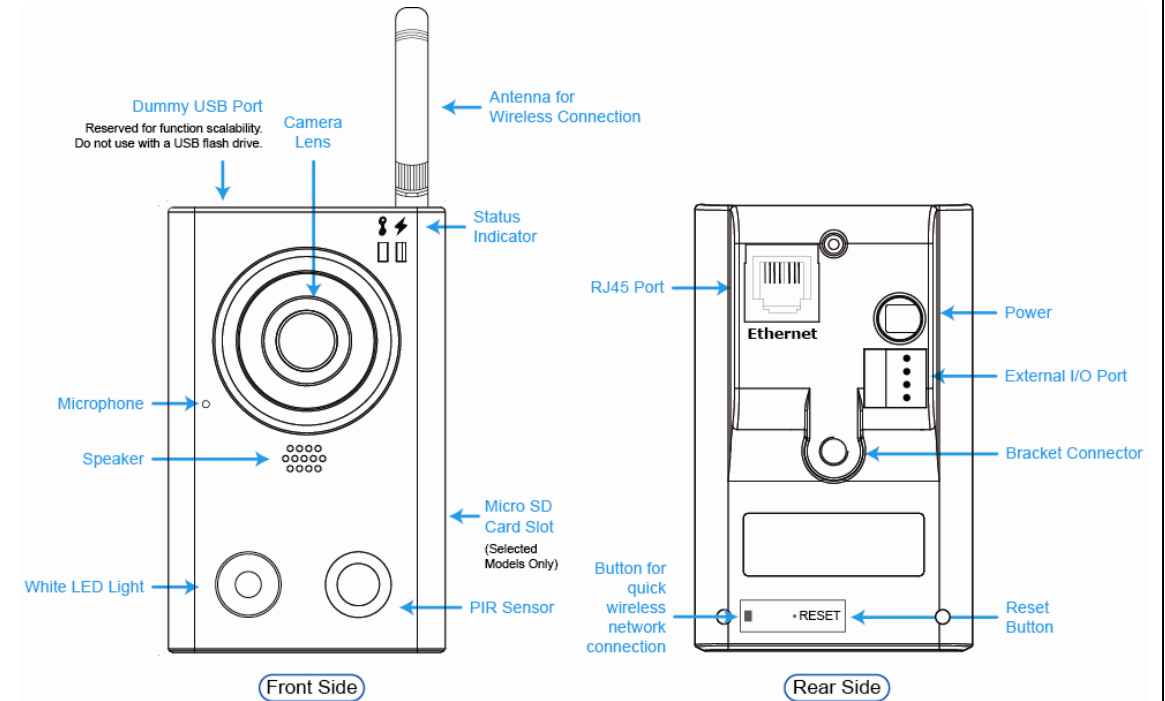

## Focus Adjustment

When you've accessed the camera successfully for the first time, it's recommended to adjust the clearness of the video by rotating the camera lens, as illustrated below.

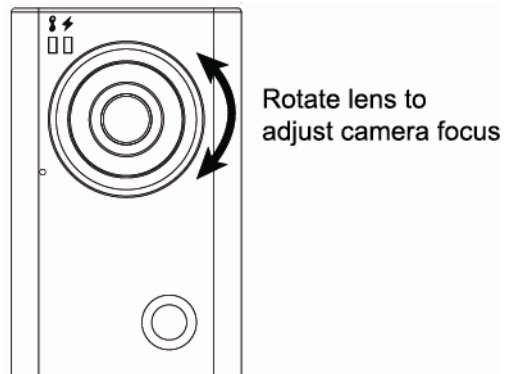

## LED Status Indicators

ICON	📶 LAN	⚡ Internet
<b>System Status</b>		
During powering on	Always on	Always off
Reset default	Blinking (on 250 ms, off 250 ms)	Always off
Upgrade	Blinking (on 250 ms, off 250 ms)	Blinking (on 250 ms, off 250 ms)
<b>Connection Status</b>		
LAN connected	Always on	--
LAN disconnected	Blinking (on 100 ms, off 500 ms)	--
Internet connected	--	Always on
Internet disconnected	--	Blinking (on 100 ms, off 500 ms)
<b>Micro SD Card Status</b>		
Micro SD Card Error	Keep current status for 20 sec → Blinking for 3 sec → Return to current status	
<b>Other Connection Status</b>		
<EaZy Networking> Failed to Connect to EagleEyes Cloud Server	Always on	Blinking (on 5 sec → off 0.5 sec → on 0.5 sec → off 0.5 sec → on 5 sec)

# PUSH VIDEO

## QUICK SETUP With EaZy Networking

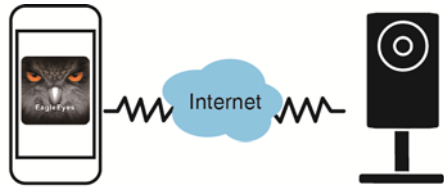

iPhone / iPad / Android  
(with EagleEyes Lite or Plus)

EaZy Networking  
Camera  
(Wired model)

FW1009

### What's EaZy Networking

EaZy Networking is a service to connect your IP camera to Internet automatically by plug and play, but it's **not free**.

To use this service, you need to create an account for the cloud service from EagleEyes.

Initially, we will provide **500MB data allowance (approx. 260 minutes) per EaZy Networking camera for free, which will be expired 6 months later** since your camera is added to the cloud server. When 500MB is out or expired, the camera connection is down.

To restore the service, users need to subscribe a data plan from us, or configure the network settings by themselves.

#### This service requires at minimum:

- a) The network environment where a router or wireless router is used with the DHCP function enabled and you know where it is.
- b) An iPhone / iPad / Android mobile device

If any of the above criteria is not met, please download the advanced network setup from our official website.

### 1 Environment Checking

- a) Do you use a router or wireless router to connect to Internet?

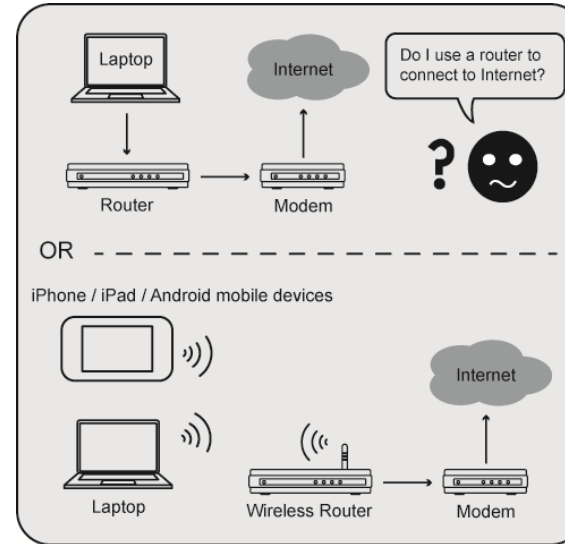

- b) You know where the router is located, and the DHCP function of your router is on.

### 2 Device Checking

- a) Your camera is powered on, and connected to the wireless router with a RJ45 network cable.
- b) Check the LED status indicators, and make sure (LAN) and (Internet) are always on.

If (Internet) is not on, make sure the DHCP function of your router is enabled, or refer to Q&A section to fix your problem.

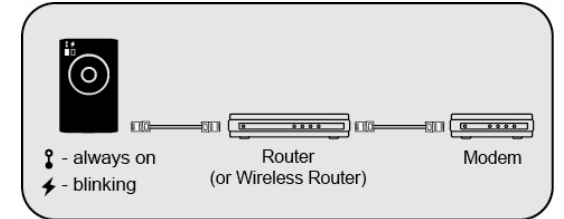

- c) You have an iPhone / iPad / Android mobile device, and it's connected to Internet by 3G networks or wireless networks.
- d) You have installed our mobile app, **EagleEyes-Lite** or **EagleEyes-Plus** on your iPhone / iPad / Android mobile device.

If no, please download from App Store. EagleEyesHD for iPad doesn't support EaZy Networking currently. Please download EagleEyes for iPhone instead.

### 3 Cloud Service Login

- a) Open EagleEyes.
- b) Create an account for the EagleEyes cloud service.



Select "+", and choose "EaZy".



If you already have a cloud service account, please sign in. For initial use, select "Register" to create an account for the cloud service. Fill in the information needed, and select "Register" to continue. This account is necessary for EaZy Networking to take effect.

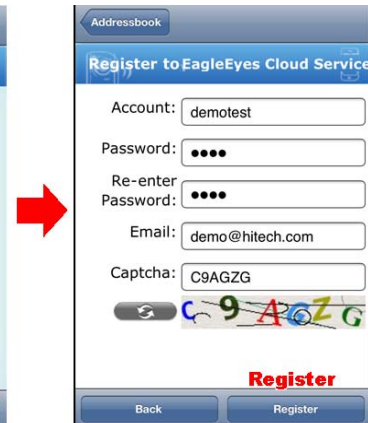

### 4 EaZy Networking Setup

- c) Select the wired device.
- d) Confirm your camera connection.
- e) Check both LED indicators.
- f) Scan or Enter the MAC address.
- g) Preview and name your camera.

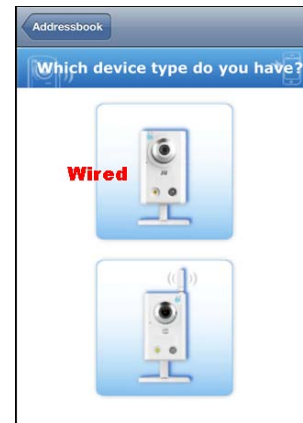

For the wired type, choose the upper one.

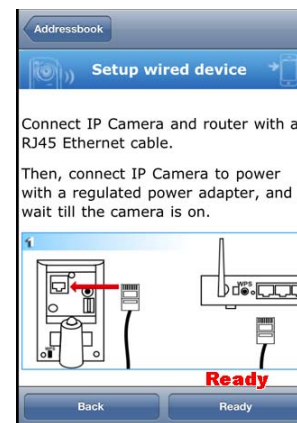

Make sure your camera setup is the same as the animation shown in this page, and choose "Ready" to continue.

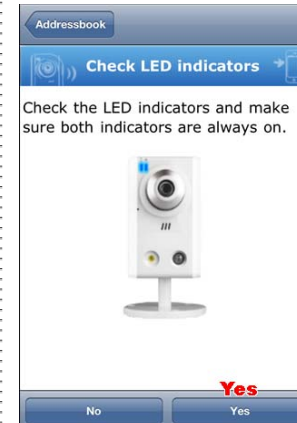

Make sure both indicators are always on, and select "Yes" to continue.



To fill in MAC, which is on the rear of the cam, you can either type it, or tap the code button and scan in the address by scanning the QR code on the back. Tap "Apply" to continue.



Check if the preview is what you need. Then, give a name to your camera if needed, or simply keep the default name, "IPCAM". Choose "Apply" to continue.

## 4 EaZy Networking Setup (Continued)

h) Complete the setup.



Your camera is added to EagleEyes cloud server successfully, and you're ready to use the camera.

Choose "Close" to complete the setup, or choose "Add another device" to add more EaZy Networking cameras.

i) Return to the address book.



Your camera is added to the address book with a cloud icon on it. Enable Push Video if needed.

Select the camera and see if you can see live view.

There will be no more necessary to memorize the address, user name, password and port number to access your camera.

Currently this service is available only on iPhone/ iPad / Android mobile device. Remote surveillance on PC will be available later.

## Account for Cloud Service

▼ Check your account.

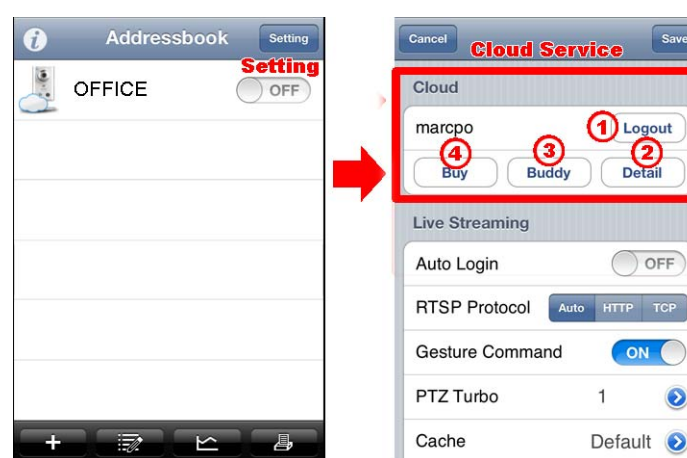

Select "Setting" on the top right corner in the address book to configure or check the cloud service.

- ① Service log in / log out
- ② Check your account information.
- ③ Share your camera / data allowance
- ④ Buy our data plan online

You must log into the service first to see your camera.

▼ Check your account information.

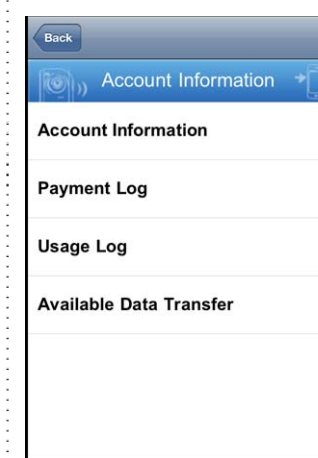

Check your account information, such as how much data allowance has been used and how much is available, and the expiration date of your purchase.

▼ Buy our data plan online.



Select any of our data plans to keep your camera online when the free 500MB data allowance is out or expired after 6 months since the camera is added to the cloud server.

Currently the plans for 1GB (USD 1) and 7GB (USD 5) are available.

## Q&A

**Q1: What are the advantages to configure your camera to Internet by using EaZy Networking?**

- A1: a) It greatly simplifies network configurations. Only plug and play and everything is done.
- b) When the camera is abnormally disconnected, such as blackout, or the connection is restored, you'll get a push message.
- c) The default access user name and password of the camera will become the ones used for your cloud service.

**Q2: What are the limitations when the camera is configured to Internet by using EaZy Networking?**

- A2: a) The IPS is 10 IPS.
- b) The live video quality is limited to QVGA

The technology of EaZy Networking is much more complicated than the traditional P2P networking, so it may take more time to get live view. To ensure you to get the live image in the shortest time, there are limitations on image quality and IPS.

**Q3: I'm not using a router to connect to Internet. Can I connect my camera to Internet by using EaZy Networking?**

A3: No. A router is needed, and its DHCP function must be on.

**Q4: How to remove a camera from the cloud service?**

A4: Please do reset default on the camera.

**Q5: My LED indicators are not always on. What should I do?**

A5:

LAN	Internet	Please check...
off	off	No power. Check if the power is connected well.
flashing	flashing	Networking failed. Check if your RJ45 network cable is connected well, or replace with a new one.
on	flashing	Flashing frequency: on 100 ms, off 500 ms Failed to connect to Internet. Check if your router is configured well for Internet access. <b>Make sure DHCP function of the router is enabled.</b>
on	flashing	Flashing frequency: on 5 sec → off 0.5 sec → on 0.5 sec → off 0.5 sec → on 5 sec Failed to connect to the cloud server. Please visit <a href="http://www.eagleeyesccctv.com/support">www.eagleeyesccctv.com/support</a> and write to us.

**Q6: How does EagleEyes charge for the cloud service?**

A6: Initially, 500MB data allowance (approx. 260 minutes) per EaZy Networking camera is provided for free, which will be expired after 6 months since the camera is added to the cloud server.

When 500MB is out or expired, users can select our data plan from EagleEyes to continue this service.

For more details, please see the regulations on the purchase page.

- USD 1 / 1GB, approx. 520 minutes
- USD 5 / 7GB, approx. 3640 minutes

**No data allowance will be charged when camera access is made by LAN, or port forwarding is made for the camera. The free 500MB data allowance can't be resumed even when the camera is reset.**

The usage time per plan is for reference only, and may vary based on the complexity of your actual monitoring area.

For details, please see the chapter "Account for Cloud Service".

For further information on EaZy Networking, please visit our official website.

[www.eagleeyesccctv.com](http://www.eagleeyesccctv.com), or go to the discussion forum [PushVideoClub.com](http://PushVideoClub.com).



# PUSH VIDEO

## QUICK SETUP With EaZy Networking

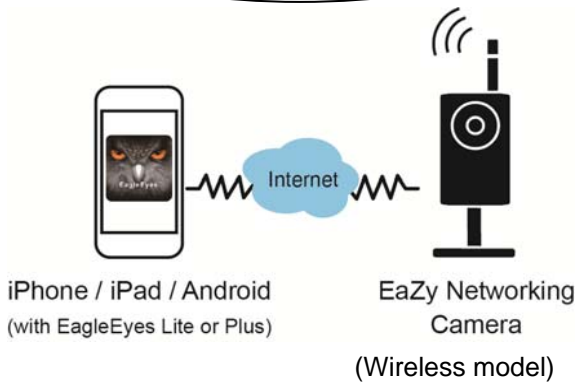

FW1009

### What's EaZy Networking

EaZy Networking is a service to connect your IP camera to Internet automatically, but it's **not free**.

To use this service, you need to create an account for the cloud service from EagleEyes.

Initially, we will provide **500MB data allowance (approx. 260 minutes) per EaZy Networking camera for free, which will be expired 6 months later** since your camera is added to the cloud server. When 500MB is out or expired, the camera connection is down.

To restore the service, users need to subscribe a data plan from us, or configure the network settings by themselves.

#### This service requires at minimum:

- a) The network environment where a router or wireless router is used with the DHCP function enabled and you know where it is.
- b) An iPhone / iPad / Android mobile device

Available for PC and Android mobile devices soon.

If any of the above criteria is not met, please download the advanced network setup from our official website for further instructions.

### 1 Environment Checking

- a) Do you use a router or wireless router to connect to Internet?

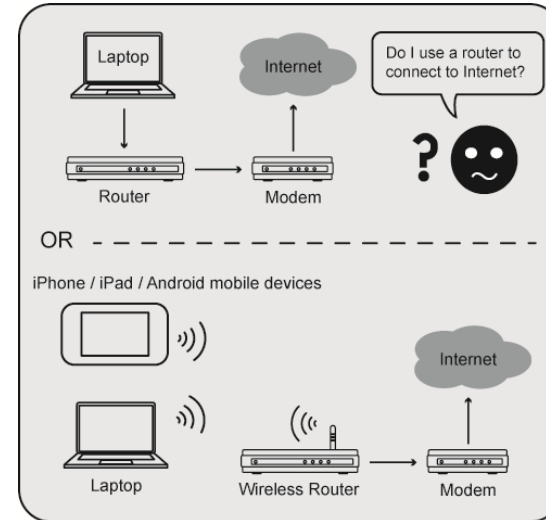

- b) You know where the router is located, and the DHCP function of your router is on.

### 2 Device Checking

- a) Your camera is powered on, and connected to the wireless router.
- b) Check the LED status indicators, and make sure LAN and Internet are always on.

If Internet is not on, make sure the DHCP function of your router is enabled, or refer to Q&A section to fix your problem.

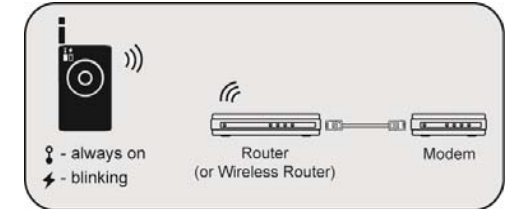

- c) You have an iPhone / iPad / Android mobile device, and it's connected to Internet by 3G networks or wireless networks.
- d) You have installed our mobile app, **EagleEyes-Lite** or **EagleEyes-Plus** on your iPhone / iPad / Android mobile device.

If no, please download from App Store. EagleEyesHD for iPad doesn't support EaZy Networking currently. Please download EagleEyes for iPhone instead.

### 3 Cloud Service Login

- a) Open EagleEyes.



Select "+", and choose "EaZy".

- b) Create an account for the EagleEyes cloud service.

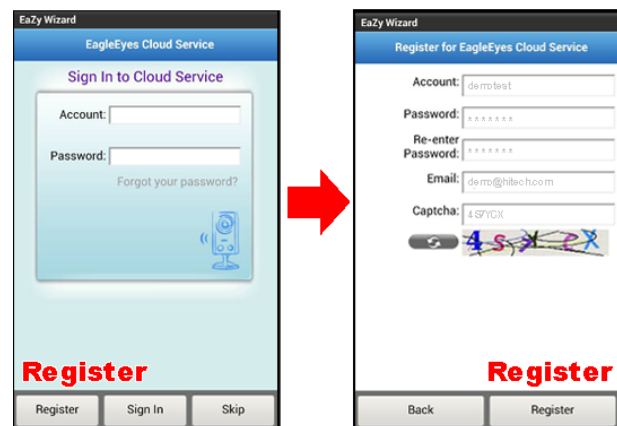

If you already have a cloud service account, please sign in. For initial use, select "Register" to create an account for the cloud service. Fill in the information needed, and select "Register" to continue. This account is necessary for EaZy Networking to take effect.

### 4 EaZy Networking Setup

- c) Select the wireless device.



For the wireless type, choose the one below.

- d) Check if your router supports WPS

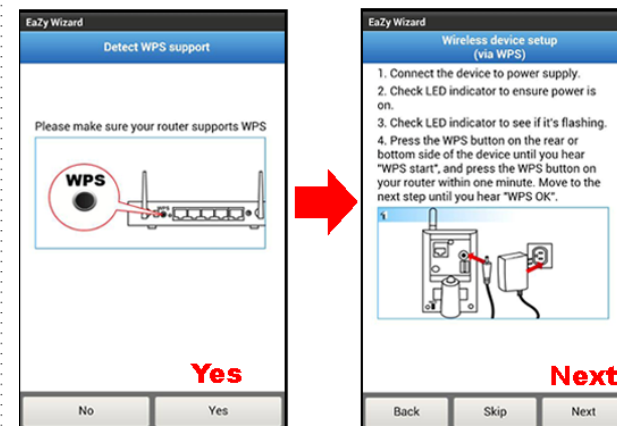

Make sure the internet is up and running, and turn on WPS on your router, and then, choose "Yes" to continue. Besides, ensure that camera setup is the same as the animation shown in this page, and then choose "Next".

- e) Check both LED indicators.

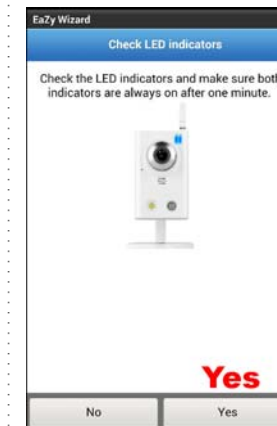

Make sure both indicators are always on, and select "Yes" to continue.

- f) Scan or Enter the MAC address.



To fill in MAC, which is on the rear of the cam, you can either type it, or tap the code button and scan in the address by scanning the QR code on the back. Tap "Apply" to continue.

## 4 EaZy Networking Setup (Continued)

g) Select the network type to connect to a wireless network.



Here you can choose the way you would like to connect your camera to the router. Select "Wireless model" to connect to a wireless network without a network cable.

If the preview is what you need, give a name to your camera, or simply keep the default name, "IPCAM". Choose "Apply" to continue.

h) Complete the setup.

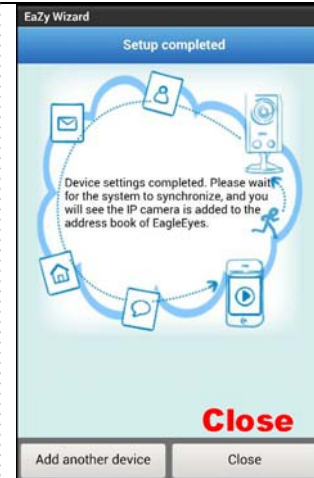

Your camera is added to EagleEyes cloud server successfully, and you're ready to use the camera.

Choose "Close" to complete the setup, or choose "Add another device" to add more EaZy Networking cameras.

i) Return to the address book.



Your camera is added to the address book with a cloud icon on it. Enable Push Video if needed.

Select the camera and see if you can see live view.

There will be no more necessary to memorize the address, user name, password and port number to access your camera.

Currently this service is available only on iPhone/ iPad / Android mobile devices. Remote surveillance on PC will be available later.

## Account for Cloud Service

▼ Check your account.

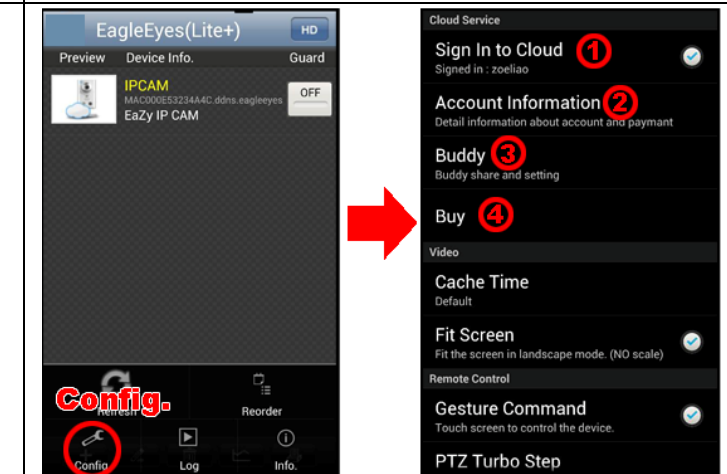

Select "Config" at the bottom of the address book to configure or check the cloud service.

- ① Service log in / log out
- ② Check your account information.
- ③ Share your camera / data allowance
- ④ Buy our data plan online

You must log into the service first to see your camera.

## Q&A

**Q1: What are the advantages to configure your camera to Internet by using EaZy Networking?**

A1: a) It greatly simplifies network configurations.

b) When the camera is abnormally disconnected, such as blackout, or the connection is restored, you'll get a push message.

c) The default access user name and password of the camera will become the ones used for your cloud service.

**Q2: What are the limitations when the camera is configured to Internet by using EaZy Networking?**

A2: a) The IPS is 10 IPS.

b) The live video quality is limited to QVGA

The technology of EaZy Networking is much more complicated than the traditional P2P networking, so it may take more time to get live view. To ensure you to get the live image in the shortest time, there are limitations on image quality and IPS.

**Q3: I'm not using a router to connect to Internet. Can I connect my camera to Internet by using EaZy Networking?**

A3: No. A router is needed, and its DHCP function must be on.

**Q4: How to remove a camera from the cloud service?**

A4: Please do reset default on the camera.

**Q5: My LED indicators are not always on. What should I do?**

A5:

LAN	Internet	Please check...
off	off	No power. Check if the power is connected well.
flashing	flashing	Networking failed. Check if your RJ45 network cable is connected well, or replace with a new one.
on	flashing	Flashing frequency: on 100 ms, off 500 ms Failed to connect to Internet. Check if your router is configured well for Internet access. <b>Make sure DHCP function of the router is enabled.</b>
on	flashing	Flashing frequency: on 5 sec → off 0.5 sec → on 0.5 sec → off 0.5 sec → on 5 sec Failed to connect to the cloud server. Please visit <a href="http://www.eagleeyescctv.com/support">www.eagleeyescctv.com/support</a> and write to us.

**Q6: How does EagleEyes charge for the cloud service?**

A6: Initially, 500MB data allowance (approx. 260 minutes) per EaZy Networking camera is provided for free, which will be expired after 6 months since the camera is added to the cloud server.

When 500MB is out or expired, users can select our data plan from EagleEyes to continue this service.

For more details, please see the regulations on the purchase page.

-- USD 1 / 1GB, approx. 520 minutes

-- USD 5 / 7GB, approx. 3640 minutes

No data allowance will be charged when camera access is made by LAN, or port forwarding is made for the camera. The free 500MB data allowance can't be resumed even when the camera is reset.

The usage time per plan is for reference only, and may vary based on the complexity of your actual monitoring area.

For details, please see the chapter "Account for Cloud Service".

For further information on EaZy Networking, please visit our official website. [www.eagleeyescctv.com](http://www.eagleeyescctv.com), or go to the discussion forum [PushVideoClub.com](http://PushVideoClub.com).